

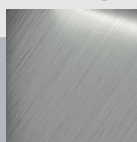

Mosiężna wkładka bębnekowa



- solidny klucz o grubości 2,4 mm
- estetycznie zaczesana cała powierzchnia wkładki
- bogata oferta rozmiarów
- dostępne w wersji nikiel oraz mosiądz
- badania  (norma PN-EN 1303:2007)

Nikiel

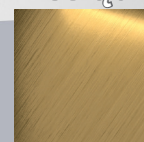

Mosiądz



-N ⁰		-N ⁰	
412.2535.10.00.M	25-35	412.2535.01.00.M	25-35
412.3030.10.00.M	30-30	412.3030.01.00.M	30-30
412.3035.10.00.M	30-35	412.3035.01.00.M	30-35
412.3040.10.00.M	30-40	412.3040.01.00.M	30-40
412.3045.10.00.M	30-45	412.3045.01.00.M	30-45
412.3050.10.00.M	30-50	412.3050.01.00.M	30-50
412.3055.10.00.M	30-55	412.3055.01.00.M	30-55
412.3535.10.00.M	35-35	412.3535.01.00.M	35-35
412.3540.10.00.M	35-40	412.3540.01.00.M	35-40
412.3545.10.00.M	35-45	412.3545.01.00.M	35-45
412.3550.10.00.M	35-50	412.3550.01.00.M	35-50
412.3555.10.00.M	35-55	412.3555.01.00.M	35-55
412.3560.10.00.M	35-60	412.3560.01.00.M	35-60
412.3565.10.00.M	35-65	412.3565.01.00.M	35-65
412.4040.10.00.M	40-40	412.4040.01.00.M	40-40
412.4045.10.00.M	40-45	412.4045.01.00.M	40-45
412.4050.10.00.M	40-50	412.4050.01.00.M	40-50
412.4055.10.00.M	40-55	412.4055.01.00.M	40-55
412.4060.10.00.M	40-60	412.4060.01.00.M	40-60
412.4065.10.00.M	40-65		
412.4545.10.00.M	45-45	412.4545.01.00.M	45-45
412.4550.10.00.M	45-50	412.4550.01.00.M	45-50
412.4555.10.00.M	45-55	412.4555.01.00.M	45-55
412.4560.10.00.M	45-60	412.4560.01.00.M	45-60
412.5050.10.00.M	50-50	412.5050.01.00.M	50-50
412.6060.10.00.M	60-60	412.6060.01.00.M	60-60

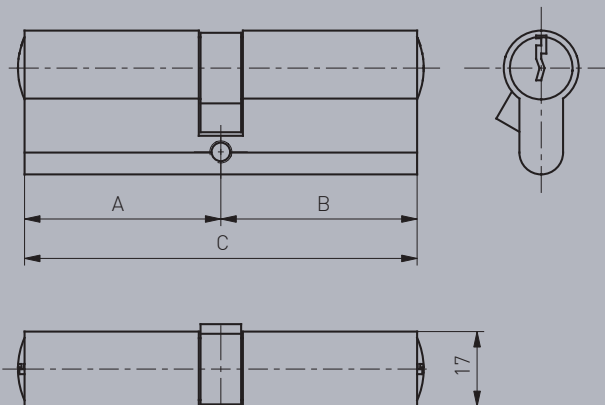

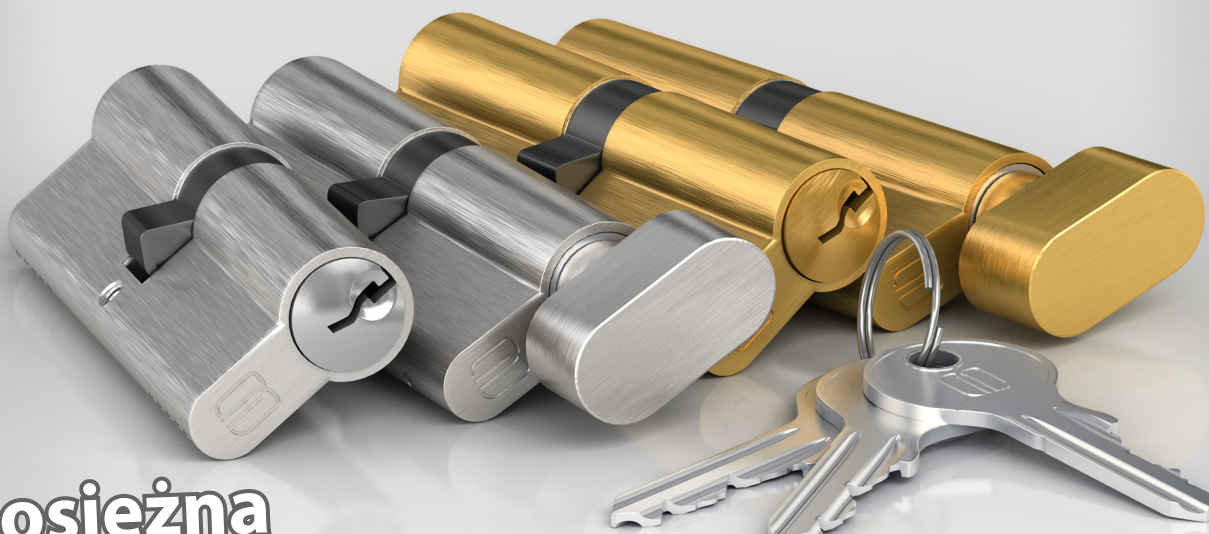

Mosiężna wkładka bębnekowa z gałką

- solidny klucz o grubości 2,4 mm
- estetycznie zaczesana cała powierzchnia wkładki
- bogata oferta rozmiarów
- dostępne w wersji nikiel oraz mosiądz

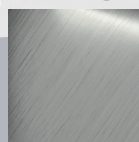

- badania [®]
(norma PN-EN 1303:2007)

Nikiel

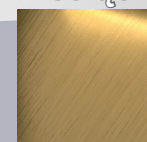

Mosiądz



-N ⁰		-N ⁰	
413.2535.10.00.M	G-25-35	413.2535.01.00.M	G-25-35
413.3030.10.00.M	G-30-30	413.3030.01.00.M	G-30-30
413.3035.10.00.M	G-30-35	413.3035.01.00.M	G-30-35
413.3040.10.00.M	G-30-40	413.3040.01.00.M	G-30-40
413.3045.10.00.M	G-30-45	413.3045.01.00.M	G-30-45
413.3050.10.00.M	G-30-50	413.3050.01.00.M	G-30-50
413.3055.10.00.M	G-30-55	413.3055.01.00.M	G-30-55
413.3530.10.00.M	G-35-30	413.3530.01.00.M	G-35-30
413.3535.10.00.M	G-35-35	413.3535.01.00.M	G-35-35
413.3540.10.00.M	G-35-40	413.3540.01.00.M	G-35-40
413.3545.10.00.M	G-35-45	413.3545.01.00.M	G-35-45
413.3550.10.00.M	G-35-50	413.3550.01.00.M	G-35-50
413.3555.10.00.M	G-35-55	413.3555.01.00.M	G-35-55
413.4030.10.00.M	G-40-30	413.4030.01.00.M	G-40-30
413.4035.10.00.M	G-40-35	413.4035.01.00.M	G-40-35
413.4040.10.00.M	G-40-40	413.4040.01.00.M	G-40-40
413.4045.10.00.M	G-40-45	413.4045.01.00.M	G-40-45
413.4050.10.00.M	G-40-50	413.4050.01.00.M	G-40-50
413.4055.10.00.M	G-40-55	413.4055.01.00.M	G-40-55
413.4530.10.00.M	G-45-30	413.4530.01.00.M	G-45-30
413.4535.10.00.M	G-45-35	413.4535.01.00.M	G-45-35
413.4540.10.00.M	G-45-40	413.4540.01.00.M	G-45-40
413.4545.10.00.M	G-45-45	413.4545.01.00.M	G-45-45
413.4550.10.00.M	G-45-50	413.4550.01.00.M	G-45-50
413.4555.10.00.M	G-45-55	413.4555.01.00.M	G-45-55
413.5030.10.00.M	G-50-30	413.5030.01.00.M	G-50-30
413.5035.10.00.M	G-50-35	413.5035.01.00.M	G-50-35
413.5040.10.00.M	G-50-40	413.5040.01.00.M	G-50-40
413.5045.10.00.M	G-50-45	413.5045.01.00.M	G-50-45
413.5050.10.00.M	G-50-50	413.5050.01.00.M	G-50-50
413.5530.10.00.M	G-55-30	413.5530.01.00.M	G-55-30
413.5535.10.00.M	G-55-35	413.5535.01.00.M	G-55-35
413.5540.10.00.M	G-55-40	413.5540.01.00.M	G-55-40
413.5545.10.00.M	G-55-45	413.5545.01.00.M	G-55-45
413.6060.10.00.M	G-60-60	413.6060.01.00.M	G-60-60

